



БАНДЖО



ЕЛЕКТРИЧЕСКА
КИТАРА



АРФА

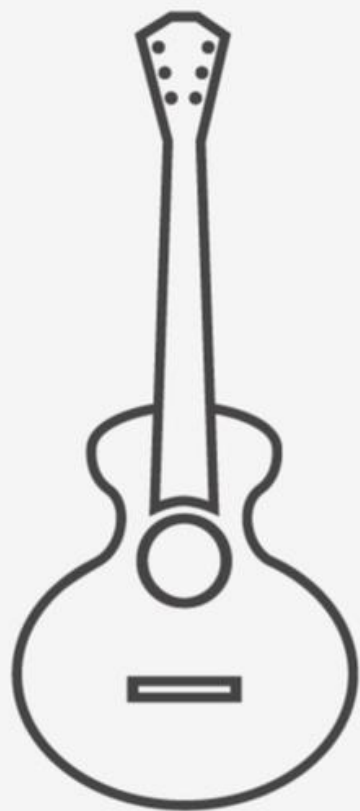

АКУСТИЧНА
КИТАРА

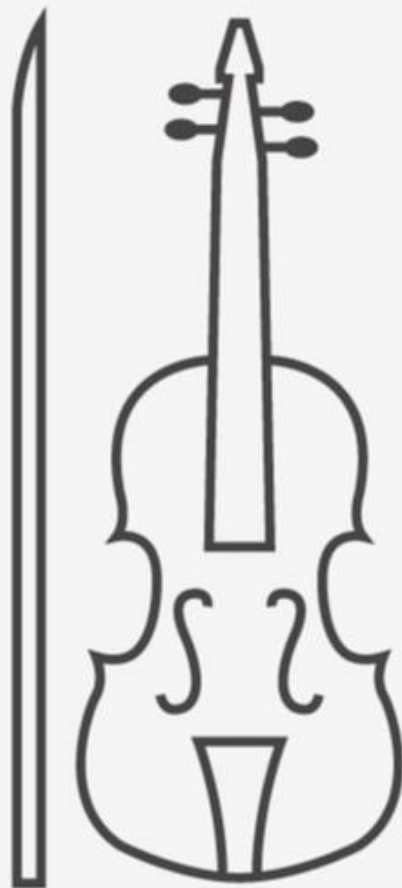

ЦИГУЛКА



ВИОЛА



КОНТРАБАС



ГЪДУЛКА



ТРОМПЕТ

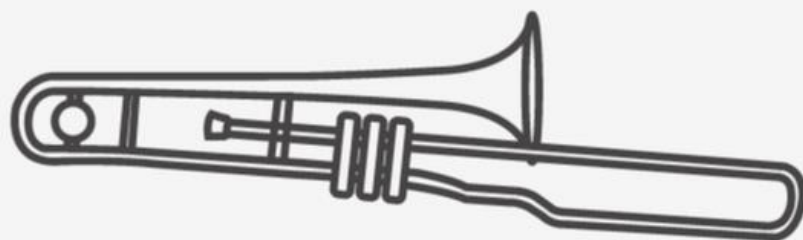

ТРОМБОН



ВАЛДХОРНА

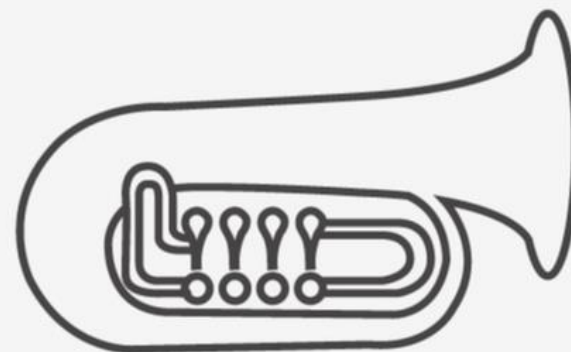

ТУБА

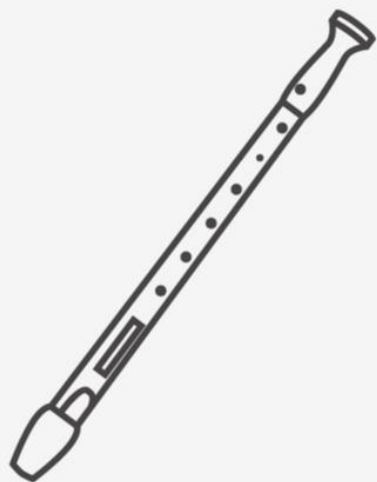

ФЛЕЙТА



ОБОЙ



КЛАРИНЕТ

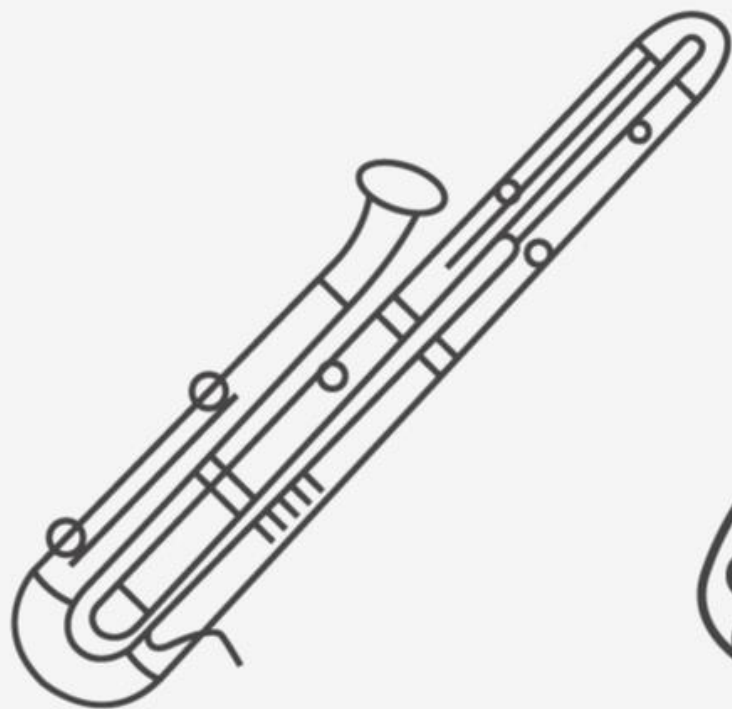

ФАГОТ



САКСОФОН

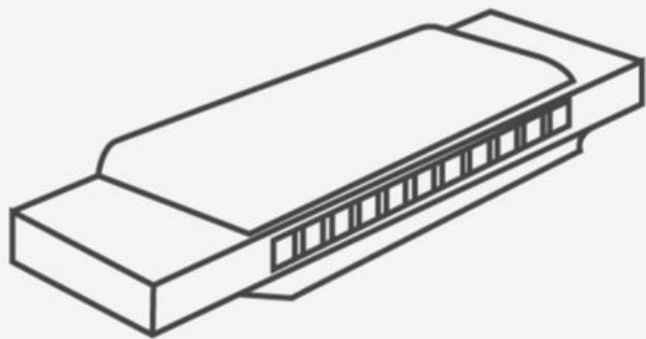

УСТНА ХАРМОНИКА

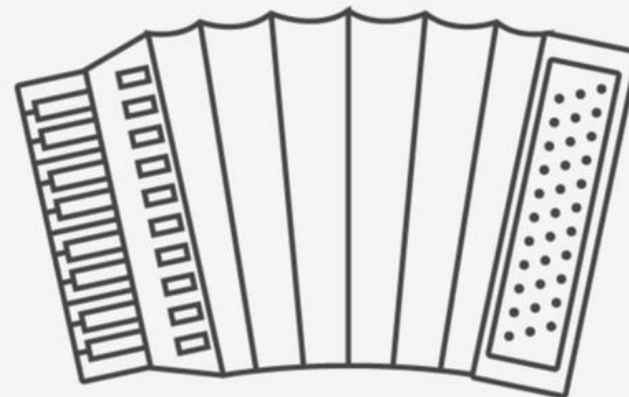

АКОРДЕОН

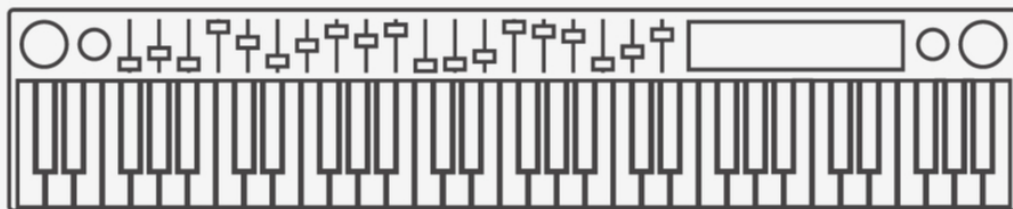

СИНТЕЗАТОР

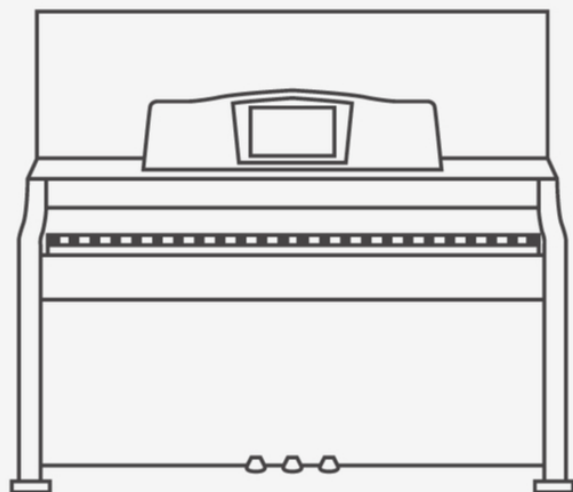

ПИАНО



КЛАВЕСИН

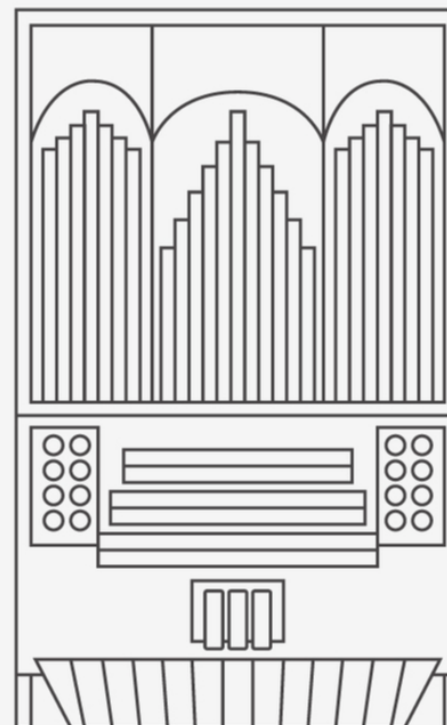

ОРГАН



КОНГА



КОМПЛЕКТ
БАРАБАНИ



ТИМПАНИ

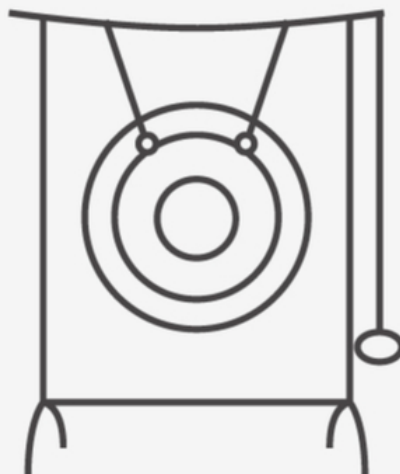

ГОНГ



ТРИАНГЕЛ/ТРИЪГЪЛНИК



БАРАБАН

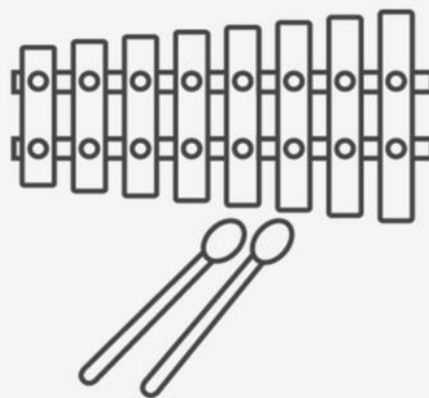

КСИЛОФОН



ДАЙРЕ

Игри:

- 1) Подредете инструментите в следните групи:
 - Струнни
 - Духови
 - Ударни
 - Клавишни
 - Електронни
- 2) Изрежете и оцветете инструментите.
- 3) Напаснете всеки инструмент към името му.
- 4) Потърсете в Интернет как звучи даден инструмент.
- 5) Кой е най-големият инструмент? А най-малкият?
- 6) Избройте някои от материалите, от които са направени инструментите
- 7) От коя държава са следните инструменти:
 - Гъдулка
 - Конга